

# SETTING STANDARDS IN THE 24.3 T TO 28.3 T CLASS.

BC 463/BC 473/BC 573.



# MILLIONS OF KILOMETRES BEAR OUR SIGNATURE.

Every contractor who wants to carry out large earthwork projects or wants to manage landfill sites, needs to be able to do one thing above all: compact. And to help you achieve the best results, we build the best machines. For over 60 years, our company's history has also been part of compaction technology history. BOMAG soil- and refuse compactors are the perfect machines for every task.

With our cumulative expertise we drive innovation and set the pace of an entire industry, also in the field of soil- and refuse compaction. At the same time we have developed many new technologies and focus on cost-effectiveness: With the unique polygonal disc wheels of the refuse compactors, which enable optimum crush-

ing, and the special BOMAG compaction concept with scrapers and toothed wheels, the soil- and refuse compactors are suitable for any situation. Our specialists working around the world and our partners in more than 120 countries are on hand to support you, from the fitting out of machines to solving the most demanding challenges.

We owe our power of innovation to more than 2,500 committed employees worldwide. This expertise has made us the world market leader in compaction. Driven by our unconditional commitment to quality: during product development and production, in training our employees, and in providing a level of service which guarantees only the best on site support.





# **BOMAG REFUSE COMPACTOR BC 463/473/573 – COMPACTION TECHNOLOGY FOR THE TOUGHEST SITES. SOMETHING EXCELLENT MADE EVEN BETTER.**

We always want to be better, and to meet the highest standards. The intelligent revised machine concept sets new standards in this machine class. Many new features big and small that make life easier and more efficient –

such as the hydraulically actuated hood and the high air intake all go to make BOMAG Landfill Compactor a reliable and efficient partner for all landfill sites.



# THE FORMULA FOR SUCCESS.

*The basis for landfill site profitability is optimum utilisation of capacity which means the best possible compaction of all waste materials. BOMAG refuse compactors achieve this requirement because they have been specifically designed to work under the extreme conditions found on landfill sites:*

- **Efficiency:** low fuel consumption means low operating costs
- **Power:** modern, high output diesel engines provide ample power for all conditions
- **Cost-efficiency:** intelligent design produces cost-effective compaction with minimum maintenance work
- **Ergonomy:** easy access to important service points on a daily basis or for scheduled maintenance
- **Versatility:** market-oriented models can be used on a variety of sites
- **Value retention:** durable technology and the highest manufacturing quality ensure high resale values
- **Security:** warranty extensions and maintenance contracts are available to suit your needs



# PLENTY OF GOOD REASONS FOR A BOMAG.

## KEEPS YOUR OPERATOR CONCENTRATED

- The spacious, vibration isolated cab with AC and airsuspended seat creates a pleasant environment. In addition we have the lowest sound level at operators ear.



## ONLY CLEAN TOOLS WORK WELL

- Scraperbars in front of and behind each wheel keeps the wheels clean.

## HIGH AVAILABILITY

- High air intake for cooling and combustion air in combination with the reversible air flow reduces the cleaning efforts down to minimum.

## EASY SERVICING

- The one-piece engine hood and the platforms left and right ensures best accessibility.



## PERFECT TRACTION AND COMPACTION

- The oscillating and articulating joint keep all four wheels on the base.

## DURABLE AND EFFICIENT

- BOMAG wheel design ensures best traction and compaction effect for many hours.

# EXHAUST LEVEL 3A / TIER 3 BC 463/473/573.

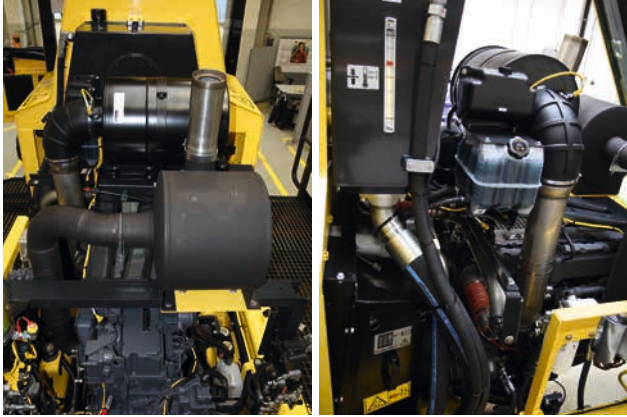

TCD 2015 V8.

- The powerful 6-cylinder turbo diesel engine handles peak workloads with ease
- Intercooler
- Compact, simple layout
- Easy servicing
- Simple exhaust system without catalytic converter or DPF
- Robust engine technology for lasting performance
- Global distribution and service
- High tolerance for variable fuel quality
- Modern injection system
- Temperature governed cooling system with speed regulated and reversible fan for highest efficiency and long maintenance intervals
- No additional operating materials



## DRIVE TRAIN.

- The matching drive train for each weight
  - BC 473 Twin-Pump-Drive
  - BC 573 Quad-Pump-Drive
- Efficient high pressure drive train
- Less components for high efficient systems
- Load limit control

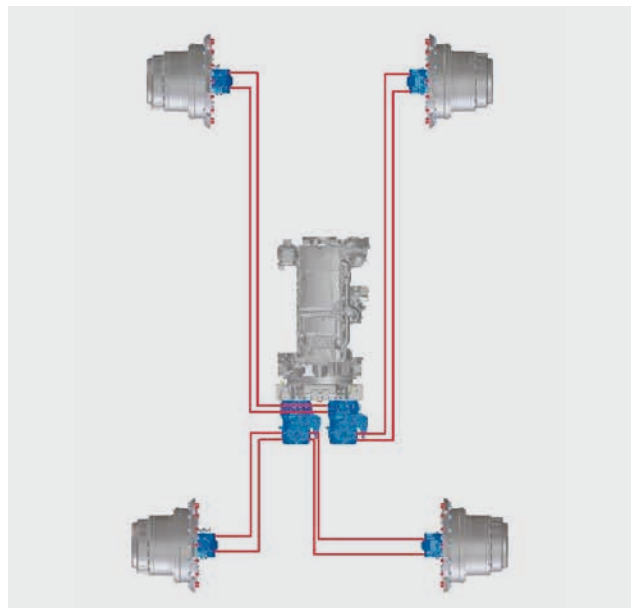

Twin-Pump-Drive (BC 463/BC 473).



# EXHAUST LEVEL 5 / 4 FINAL BC 473/573.

- This well designed and powerful turbo diesel engine uses newest technology to provide power for all site situations, with low fuel consumption rates
- Intercooler
- High pressure direct fuel injection
- Top actual technic in well known quality
- Global distribution and service
- 10 % less fuel consumption
- Lower operation costs
- Low vibration 6-cylinder in line engine
- Temperature governed cooling system with speed regulated and reversible fan for highest efficiency and long maintenance intervals



Well known, means facturer.

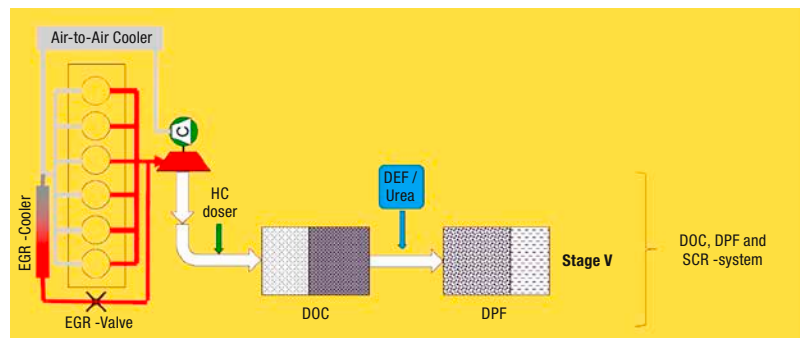

Exhaust after-treatment system.

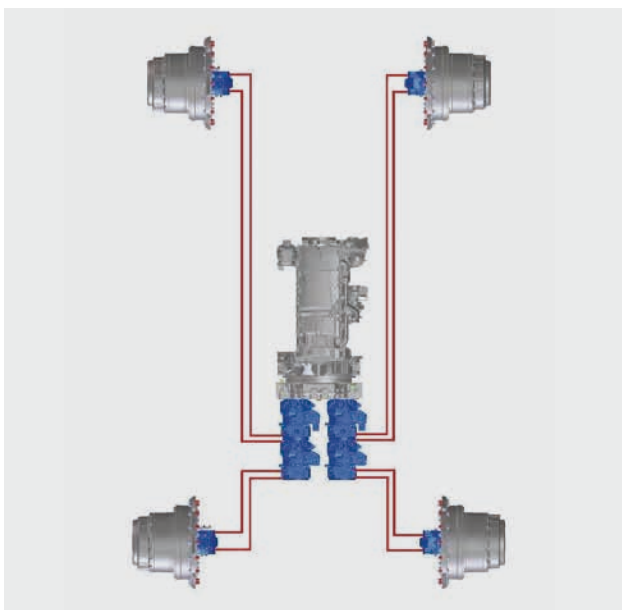

Quad-Pump-Drive (BC 573).

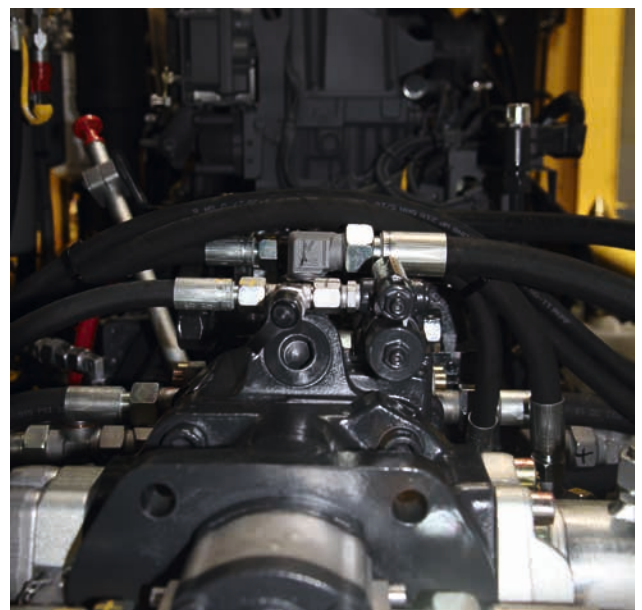

# SUSTAINABILITY.

*As market leader in compaction technology, BOMAG is highly focused all factors affecting sustainability. This includes efficient handling of natural resources during manufacturing and during their use on site. In support of this concept BOMAG puts sustainability into practice in the design and manufacture of its refuse compactor product range.*

## **RECYCLABLE MATERIALS.**

In the refuse compactor market it is important to present sustainability positively and properly supported with facts for the tendering process. BOMAG selects raw materials with the highest recycling potential – BOMAG refuse compactors are over 92% recyclable.

## **EFFECTIVE DRIVE TECHNOLOGY.**

BOMAG refuse compactors use a high-pressure hydraulics system. The system has few components in the drive train, producing a high level of efficiency with low energy consumption. Speed-controlled radiator fans provide an adapted air flow to cool the engine saving approx. 5% in fuel.



### **LOW EMISSIONS.**

BOMAG has long, practical experience with efficient systems through adopting emissions regulations early on. The intelligent BOMAG cooling system combined with the latest engine technology brings tangible benefits to users. All BOMAG refuse compactors are equipped with engines which comply with exhaust regulations. BOMAG continues to meet the challenges of modern day environmental protection whilst delivering impressive, powerful and efficient technology.

### **REDUCED POLLUTION FOR THE OPERATOR AND ENVIRONMENT.**

The outstanding cooling system allows BOMAG refuse compactors to work extremely quietly, providing the operator and surrounding area with a good working environment. Pollution caused by dust and gas is kept to a minimum by the cab filter system.



# SHIFTING AND DISTRIBUTING REFUSE.

The basis for good compaction is the distribution of refuse into suitable layer thicknesses. For even distribution the operator requires precision machinery, high thrust forces and high traction. All standard with BOMAG refuse compactors!

The joystick is easy and stress free which means good precision when working long shifts. The smooth hydrostatic drive converts the power of the water-cooled turbo

diesel engine into high output power. The load limit control smoothly adjusts the travel speed automatically to the load for optimum utilisation of the power available. The unique feature is the oscillating articulated joint which is designed to withstand the toughest loads and stresses of landfill site operation. The joint allows 15° oscillation and 40° (35° RS version) steering to either side between front and rear frames. The result is all wheels maintain ground contact for optimum compaction, safety and traction.



High traction with the oscillating articulated joint (continuous ground contact).



Hydraulic wheel drive with „load limit control“ (load-related speed control) (BC 473).

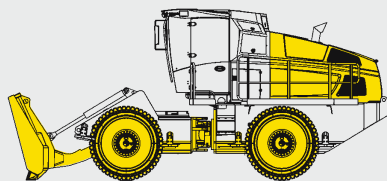

High pushing power with the dozer blade range optimised for every application.



Clean wheels with effective scrapers (optimum compaction).

# ALL ROUND PERFORMANCE.

*In the 24.3 t to 28.3 t class, BOMAG offers three models with dozer blades (RB) and the 25.7 t version with loading bucket (RS-4).*

## DOZER BLADES

- Dozer blade with grid attachment for a good all-round overview
- Three rotatable cutting blades and two edge
- Straight blade
- Semi-U-blade for 10% more pushing performance



RB version with semi-U-blade.



Semi-U.



Shovel.

## RS VERSION WITH HYDRAULIC LIFTING GEAR

- For universal use (transportation, handling and loading)

## BUCKET FOR RS VERSIONS

- Robust bucket with grid attachment for good visibility
- Available with a cutting edge or bucket with three-part teeth in quick change holders\*

\* optional



BC 473 RS.

# COMPACTION.

If material is evenly distributed the best compaction possible can be achieved – BOMAG's core competence. Compaction significantly affects the life of any landfill site. With the high investments involved in landfill sites every addi-

tional m<sup>3</sup> filled is money earned. BOMAG achieves optimum compaction with its wheel geometry, scraper beams and stable ground contact.

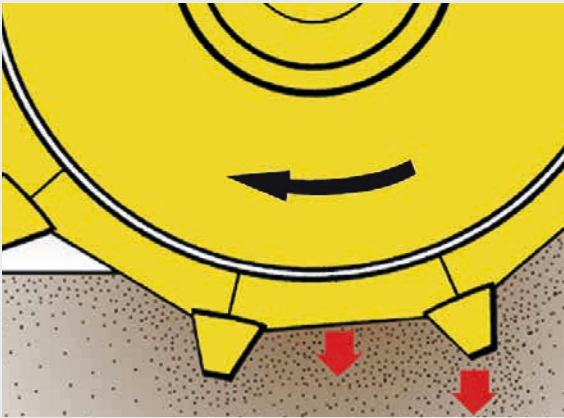

Polygon disc wheels with compressor teeth for crushing, kneading and effective compaction at depth.



Optimum compaction with the oscillating joint, providing good load distribution to the compaction wheels.

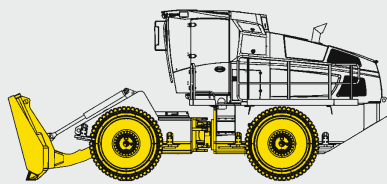

Scrapers guarantee clean wheels and high compaction.

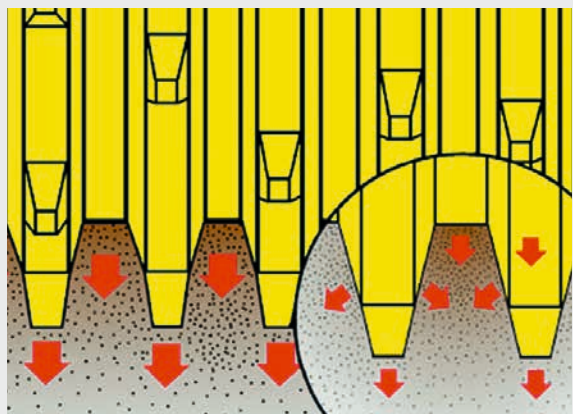

Additional lateral forces increase compaction.

# THE RIGHT TOOTH MAKES THE DIFFERENCE.

*BOMAG offers wheels with replacement caps or with premium teeth for outstanding crushing and compaction.*

## **BOMAG WHEELS WITH REPLACEMENT CAPS**

- Welded wheel bodies with inner taper on both sides for optimum stability
- Specially shaped polygon compaction segments with attached replacement cap holders welded on to assist compaction
- Equipped with high quality, forged replacement caps for optimum refuse crushing and compaction
- Precision mounting ensures the caps fit tightly and securely
- Caps can be changed easily and quickly by ejecting the dowel pins
- Optimised ejector tool available



Adjustable scraper for uninterrupted operations.

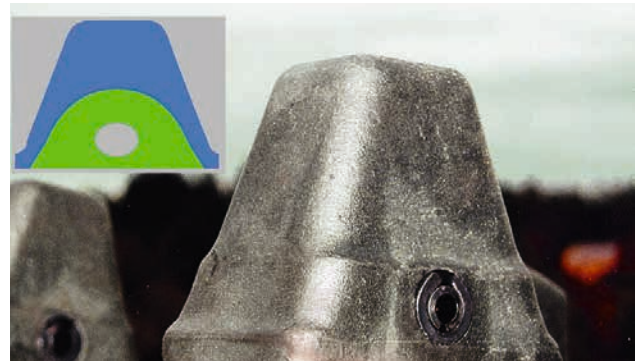

High quality, forged quick-change replacement caps.

## **BOMAG WHEELS EQUIPPED WITH PREMIUM TEETH, WHICH HAVE A WEAR WARRANTY OF 10,000 WORKING HOURS (PRORATED)**

- Welded wheel bodies with inner taper on both sides for optimum stability
- Armouring welded to the wheel edges for extended service life in combination with the cable cutters
- Specially shaped polygon compaction segments with attached compaction teeth are welded to assist compaction
- Compaction teeth made of high wear-resistant cast composite; that is, two materials cast in sequence for longer service life



Welded wheel bodies with inner taper on both sides for optimum stability (premium).

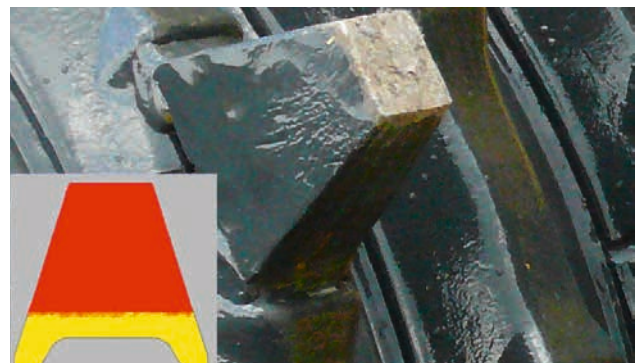

Premium teeth with a wear warranty of 10,000 hours.

# ERGONOMICS AND EASE OF OPERATION.

*An underestimated factor: why invest in an efficient machine if the operator is unable to achieve the best results after a few hours due to fatigue?*

BOMAG prevents driver fatigue with a flexibly mounted cab, an ergonomically designed workplace and low sound pressure level. There are optional extras available to make

it easier for the operator to monitor the machine or for increased comfort and convenience.



Cab with large windcreens to ensure the best overview of the working environment.



The ergonomically designed, comfortable workplace for fatigue-free work.

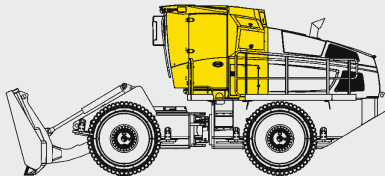

Joystick control – the compactor stays under complete control with ease.

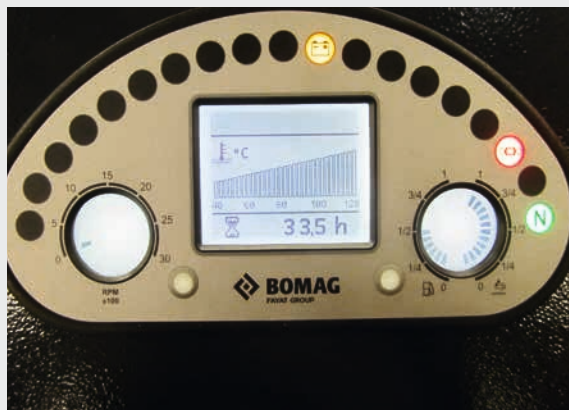

All important information arranged in the field of vision ensuring the operator stays up-to-date.



# MORE COMFORT AND CONVENIENCE.

## HIGH COMFORT CAB

- The comfortable cab meets ROPS and FOPS regulations
- Two level mounted, vibration isolated

## CONFIGURATION:

- Heating/air conditioning system (manual)
- Work lights
- Two large exterior rear-view mirrors
- Large storage spaces
- Safety glass
- Windscreen wiper with washer system

## AIR-CUSHIONED OPERATOR'S SEAT

- Ergonomically shaped, comfortable heated seat with pneumatic suspension. APS (Automatic Positioning System) always ensures the best position to access the operating controls

## AUXILIARY HEATING (AIRTRONIC)\*

- Auxiliary heating independent of the engine (air heating), in addition to the existing heating system

## AIR CONDITIONING AUTOMATIC\*

- Fully automatic adjustment to keep the selected temperature

\* optional



Cab comfort with ROPS and FOPS as standard.



The workplace.



Air conditioning automatic.



Airtronic auxiliary heating.

# SAFETY IS STANDARD.

For BOMAG safety has no room for compromise. In the standard versions BOMAG refuse compactors meet all safety-related requirements for everyday use on landfill

sites. Also every compactor can be adapted to any job with a range of options. These compactors can be configured for all site requirements.

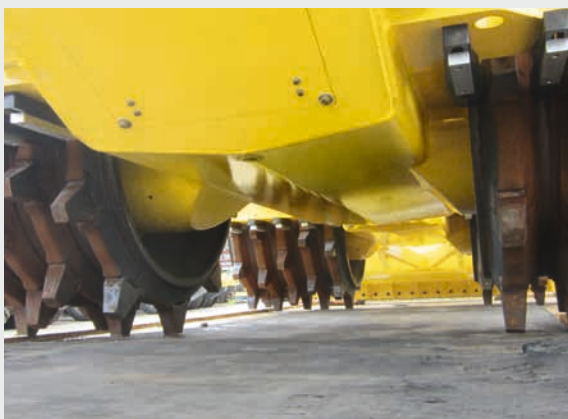

Frame with enclosed sections for best possible protection of all components and no ingress of material; no danger of ignition on hot components.



Cab design complies with ROPS and FOPS regulations.

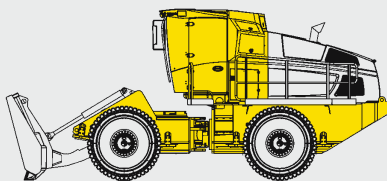

Two independent braking systems (hydrostatics used for service brake, multiple discs for the parking brake).

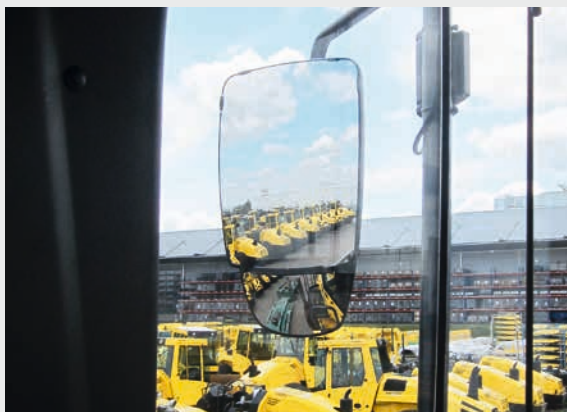

Large mirrors on both sides combined with large glass areas for excellent all-round visibility.

# MAKING WORKING LIFE EASIER.

## SERVICE PLATFORM

The open surface keeps it clean. Non slip design for platforms and steps makes it save.

## REVERSING CAMERA

This reversing monitoring system comprises a video camera at the rear and a colour display (screen) in the operator's cab – for optimum overviews of the work area. The screen can be removed easily and reinstalled; e.g. for storage safely outside working hours.

## FIRE EXTINGUISHER\*

Hand fire extinguisher with 6 kg content. This fire safeguard always on board.

## PRELIMINARY FITTING OF PROTECTIVE VENTILATION SYSTEM\*

The high concentration of dust on landfill sites makes work more demanding. Pollution hazards for the operator can often only be reduced with special filter technology. Here BOMAG offers pre-fitting of the cab to install this technology. This allows the opportunity to set up a filter system using your specialist supplier tailored to your requirements.

\* optional

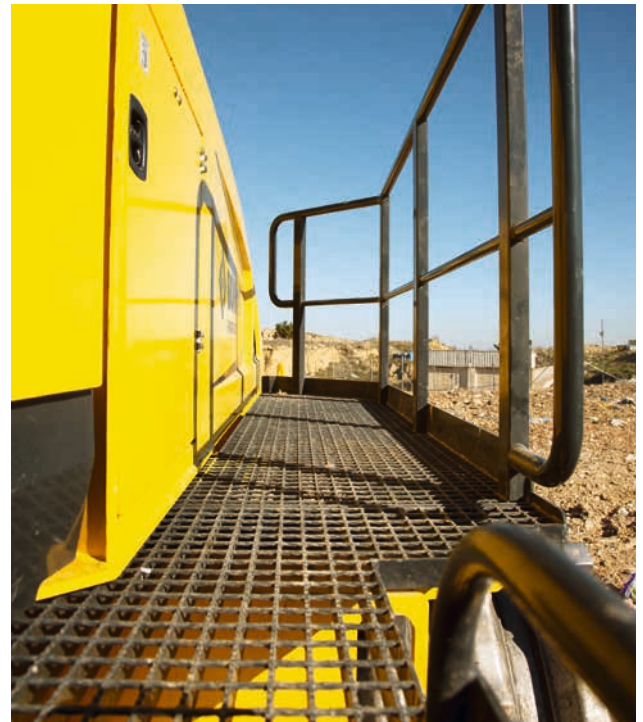

Access to the workplace.



Eyes to the rear.



Hand held fire extinguisher.

# EASY SERVICE.

Maintenance does incur costs so BOMAG's development aim is always to keep costs to a minimum for maintenance work. Major improvements have been achieved by arranging component layouts to good effect and combin-

ing this with high accessibility. Machine options also reduce scheduled expenses, cut running costs, and provide easy maintenance needed for heavy site work.



High level suction for cooling and combustion air with minimum dust levels.



Fast access to maintenance points.

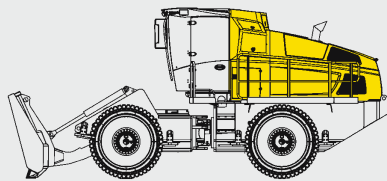

Access from all sides.



Well protected control centre in the cab.

# SAVES TIME.

## ■ SERVICE PLATFORM

The service platforms are on both sides of the machine to facilitate access to the maintenance areas and are a valuable aid to fast and safe maintenance work.

## ■ CENTRAL LUBRICATION SYSTEM\*

A central lubrication system supplies nearly all mechanical bearing points. The lubricant container with agitator allows lubricant to be conveyed free of air. Automatic interval function. The capacity of the grease container enables a sufficient supply for up to 500 operating hours. A malfunction alarm guarantees safe supply to lubricating points.

## ■ WARRANTY EXTENSION AND MAINTENANCE CONTRACTS\*

BOMAG Service will customise available packages to suit individual requirements to fix long term operating costs. Customers are protected from unpredicted costs for true added value.

\*optional



The service platform gives access to the maintenance area.



Running smoothly...



Normal operation.

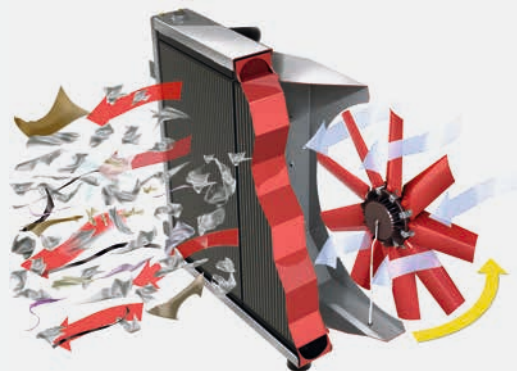

Reserve operation.

# CUTTING COST AND DURABILITY.

By using the latest, well designed components from reputable suppliers, BOMAG ensures that the financial goals of customers are met, not just in the first few years, but

throughout the life cycle of the machine. To maintain high efficiency in the long-term all components are protected by highly effective filter technology.



Discharge side of the hydraulic filter system.



Hydraulics designed for continuous long term operation.

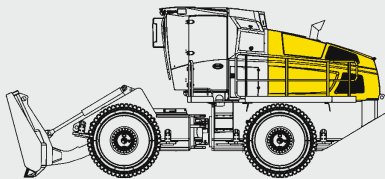

Electronic monitoring of hydraulics return filter system.



Multi-stage fuel filtering.

# MAINTENANCE, SERVICE AND WARRANTY.

## YOU WANT:

A high availability and long life for your investment with minimum operating costs.

## OUR SOLUTION:

Save time and money with BOMAG spare parts and service products!

- Avoid expensive consequential damage by alternative parts sourcing. Only BOMAG original spare parts meet your refuse compactor requirements for quality and functionality.

- BOMAG cooling agents and lubricants meet the high requirements of our machine components and maximise maintenance cycles and component service life.
- BOMAG service kits contain all parts needed for professional maintenance in one package at attractive prices. It could not be easier.

You can rely on BOMAG for service and spare parts and in so doing avoid unwelcome operating surprises.

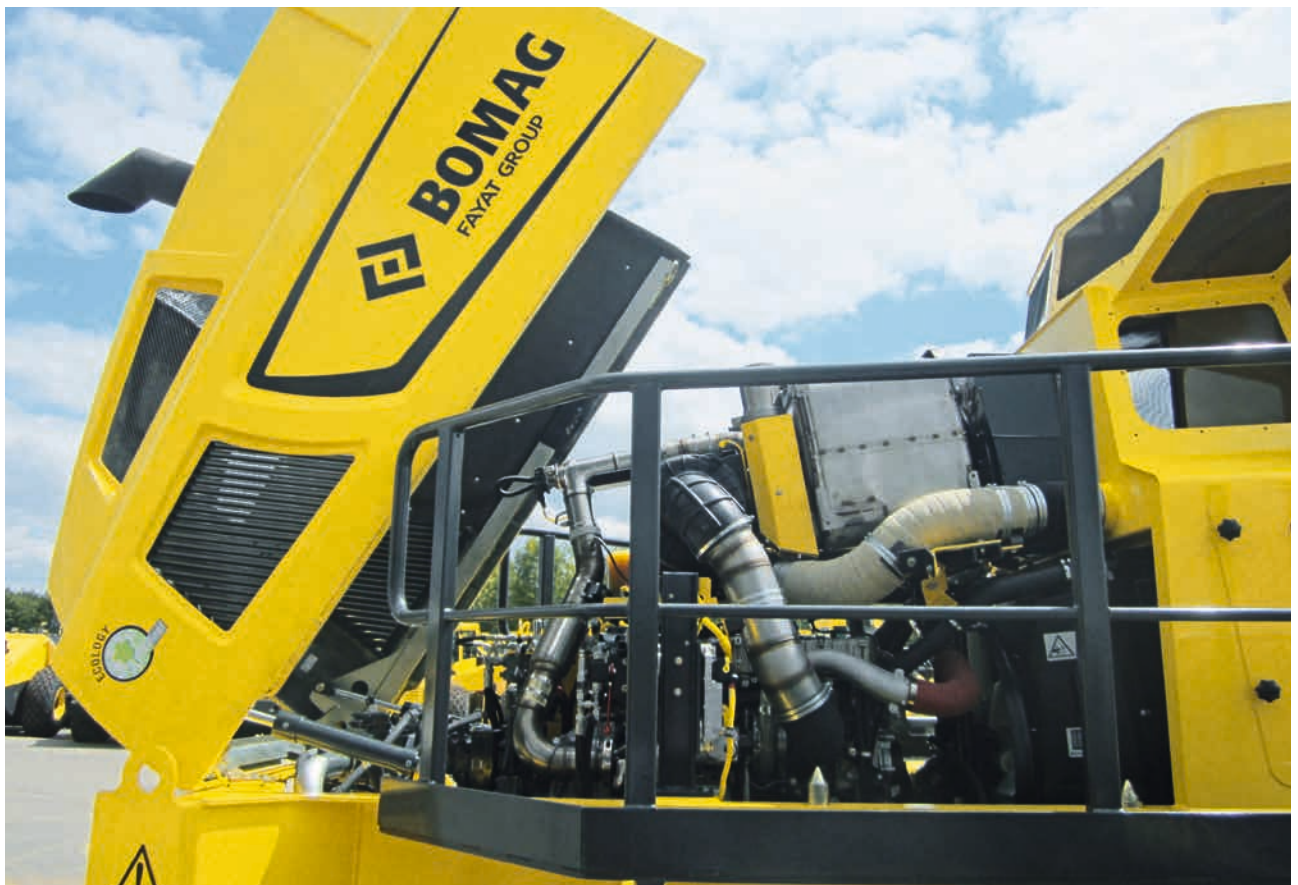

# BOMAG TELEMATIC.\*

## YOUR MACHINE IS JUST A MOUSE CLICK AWAY.

BOMAG also supports customers in the back office. BOMAG TELEMATIC provides the most important machine data at all times – e.g. operating hours and machine output – regardless of machine location. BOMAG TELEMATIC will monitor and manage the entire fleet. Customers know at all times where the machines are, how they are being used and when the next service is due. Alarms are automatically generated; for example, when a machine leaves a defined construction site at an unscheduled time. BOMAG TELEMATIC also allows fuel costs to be allocated in detail and servicing work to be planned and documented. All of the recorded data can be tracked.

- **Maintenance scheduling:** The entire fleet at a glance. All services are centrally documented.
- **Full fuel monitoring:** BOMAG TELEMATIC provides precise information about actual fuel consumption.
- **Flexibility:** BOMAG TELEMATIC is the solution for the entire fleet: machines from other manufacturers can be readily incorporated.

\*optional

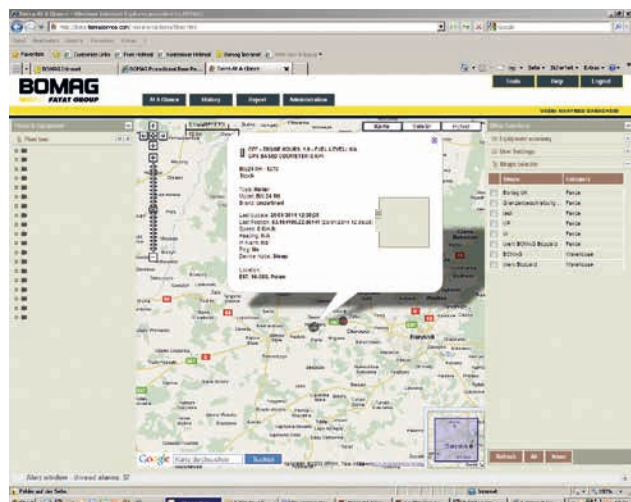

Know where machines are at all times.

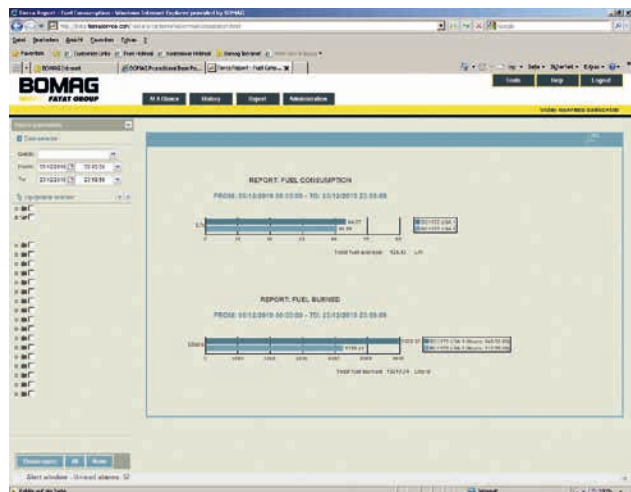

Fuel costs can be allocated in detail.



# MODEL OVERVIEW.



Model types	BC 463 RB-3	BC 473 RB-3	BC 473 RS-3	BC 573 RB-3	BC 473 RB-5	BC 473 RS-5	BC 573 RB-5
Weight [t]*	24.3	25.7	25.4	28.0	26.0	25.7	26.0
Power [kW/hp]	227 / 304	227 / 304	227 / 304	227 / 304	210 / 281	210 / 281	210 / 281
Emission stage	3 / 3a	3 / 3a	3 / 3a	3 / 3a	5 / 4f	5 / 4f	5 / 4f

\*) Approximate operating weights with cabin in the basic configuration. Actual weights depend on equipment and accessories. Technical specifications subject to change. Machines may be shown with optional accessories.



BC473 RB

BOMAG  
FAYAT GROUP



Head Office:

**BOMAG**  
Hellerwald  
56154 Boppard  
GERMANY  
Tel. +49 6742 100-0  
info@bomag.com

**BOMAG Maschinen-  
handels-gesellschaft m.b.H.**

Klausenweg 654  
2534 Alland  
AUSTRIA  
Tel. +43 2258 20202  
austria@bomag.com

**BOMAG MARINI EQUIPAMENTOS LTDA.**

Avenida Clemente Cifali, 530  
Distrito Industrial Ritter  
Cachoeirinha – RS  
BRAZIL  
ZIP code 94935-225  
Tel. +55 51 2125-6642  
brasil@bomag.com

**BOMAG (CANADA), INC.**

2233 Argentia Road, East Tower  
Suites 302  
L5N 2X7 Mississauga, ON  
CANADA  
Tel. +1 800 782 6624  
canada@bomag.com

**BOMAG (CHANGZHOU)**

Construction Machinery Co., Ltd.  
No. 66 Bopa Road  
Xuejia Town  
Xinbei District  
Changzhou 213125  
CHINA  
Tel: +86 519 88585566  
china@bomag.com

**BOMAG India Pvt Ltd**

Unit No. 614, B Wing, 6th Floor  
Kanakia Wall Street  
Chakala Andheri Kurla Road Andheri East  
Mumbai 400 093 Maharashtra  
INDIA  
Tel.: +91 8657492418  
india@bomag.com

**BOMAG France S.A.S.**

2, Avenue du Général de Gaulle  
91170 Viry-Châtillon  
FRANCE  
Tel. +33 1 69578600  
france@bomag.com

**BOMAG (GREAT BRITAIN), LTD.**

Sheldon Way  
Larkfield, Aylesford  
Kent ME20 6SE  
GREAT BRITAIN  
Tel. +44 1622 716611  
gb@bomag.com

**BOMAG Italia**

Via Roma 50  
48011 Alfonsine  
ITALY  
Tel. +39 0544 864235  
italy@bomag.com

**FAYAT BOMAG Polska Sp. z o.o.**

Ul. Szyszkowa 52  
02-285 Warszawa  
POLAND  
Tel. +48 22 482 04 00  
poland@bomag.com

**FAYAT BOMAG RUS OOO**

141400, RF, Moscow region  
Khimki, Klayazma block, h. 1-g  
RUSSIA  
Tel. +7 (495) 287 92 90  
russia@bomag.com

**BOMAG GmbH**

300 Beach Road  
The Concourse, #18-06  
Singapore 199555  
SINGAPORE  
Tel. +65 6 294 1277  
singapore@bomag.com

**BOMAG Americas, Inc.**

125 Blue Granite Parkway  
Ridgeway SC 29130  
U.S.A.  
Tel. +1 803 3370700  
usa@bomag.com

