

KOMATSU®

D375A-6R

HORSEPOWER

Gross: 474 kW 636 HP @ 1800 rpm

Net: 455 kW 610 HP @ 1800 rpm

OPERATING WEIGHT

70235 kg 154,840 lb

D
375A

CRAWLER DOZER



Photo may include optional equipment.

WALK-AROUND

SAA6D170E-5 turbocharged after-cooled diesel engine provides an output of **474 kW** 636 HP with excellent productivity.

See page 6.

Preventative maintenance

- Centralized Service Station
- Enclosed Hydraulic Piping
- Modular Power Train Design
- Oil Pressure Checking Ports

See page 9.

Automatic transmission with lockup torque converter increases speed and power to improve fuel consumption and productivity.

See page 6.

Large blade capacities:

18.5 m³ 24.2 yd³ (Semi-U dozer)
and **22.0 m³** 28.8 yd³ (U dozer)

Simple hull frame

and monocoque track frame with pivot shaft for greater reliability.

The **Dual tilt dozer**

(optional) increases productivity while reducing operator effort.

See page 6.

Track link design

reduces maintenance cost by making turning pins easier, with improved pin reuse.

See page 9.

Komatsu-integrated design

for the best value, reliability, and versatility. Hydraulics, power train, frame, and all other major components are engineered by Komatsu. You get a machine whose components are designed to work together for higher production, greater reliability, and more versatility.

Hydraulic drive radiator cooling fan

controlled automatically, reduces fuel consumption and operating noise levels.

See page 6.



Low-drive, long-track, seven roller undercarriage

provides outstanding grading ability and stability.

Track shoe slip control system (optional)

reduces operator fatigue.

See page 7.

Hexagonal designed cab includes:

- Spacious interior
 - Comfortable ride with cab damper mounting and K-bogie undercarriage
 - Excellent visibility
 - High capacity air conditioning system (optional)
 - PCCS (Palm Command Control System) lever
 - Pressurized cab (optional)
 - Adjustable left armrest
 - Travel control console integrated with operator seat
- See page 8.

Large TFT LCD monitor

- Easy-to-see and use 7" large multi-color monitor.
- Can be displayed in 10 languages for global support.

TFT : Thin Film Transistor

LCD : Liquid Crystal Display

See page 8.

HORSEPOWER
 Gross: 474 kW 636 HP @ 1800 rpm
 Net: 455 kW 610 HP @ 1800 rpm

OPERATING WEIGHT
 70235 kg 154,840 lb

BLADE CAPACITY
 Semi-U: 18.5 m³ 24.2 yd³
 Full-U: 22.0 m³ 28.8 yd³

ECMV (Electronic Controlled Modulation Valve) controlled steering clutch/brake system facilitates smooth and shockless steering operation.

See page 5.

PCCS (Palm Command Control System)

- Electronic controlled PCCS travel control
- Hydraulic controlled PCCS blade/ripper control
- Fuel control dial
- Automatic/manual gearshift selectable mode
- Gearshift pattern preset function
- ECMV controlled transmission

See page 4.

**Rippers (optional):**

- Variable giant
- Multi-shank

See page 7.

Photo may include optional equipment.

K-Bogie undercarriage system

High traction, component durability, and operator comfort.

See page 8.

Extra-low machine profile

provides excellent machine balance and low center of gravity.

CONTROL FEATURES

Komatsu's new ergonomically designed control system "PCCS" creates an operating environment with "complete operator control."

Human-Machine Interface

Palm command electronic controlled travel control joystick

Palm command travel joystick provides the operator with a relaxed posture and superb fine control without operator fatigue. Transmission gear shifting is simplified with thumb push buttons.

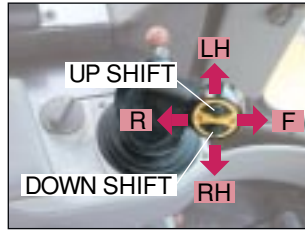

Fully adjustable suspension seat and travel control console

For improved rear visibility during return part of cycle, the operator can adjust the seat 15° to the right. The transmission and steering controls move with the seat for best operator comfort. The travel control console also has adjustments fore and aft and for height. With an independently adjustable armrest, each D375A operator can adjust control positions to his individual preference, providing optimum operational posture for all operators.

Facing front



When turned 15°



Fuel control dial

Engine speed is controlled by electric signals, providing ease of operation eliminating maintenance of linkage and joints.

Palm command PPC controlled blade control joystick

Blade control joystick uses the PPC (Proportional Pressure Control) valve and the same palm command type joystick as travel control joystick. PPC control, combined with the highly reliable Komatsu hydraulic system, provides superb fine control. (Dual tilt and pitch operation are activated by depressing switch with a thumb. This is available with optional dual tilt dozer.)

Blade and ripper control joysticks



Height adjustable blade control armrest

Blade control armrest is height adjustable without any tools in three stages, providing the operator with firm arm support and ideal armrest positioning.

Position adjustable ripper control lever

Ripper control lever is position adjustable, providing optimum operation posture for all operators during ripping operations facing front or watching ripper point.

Outline of electronic control system

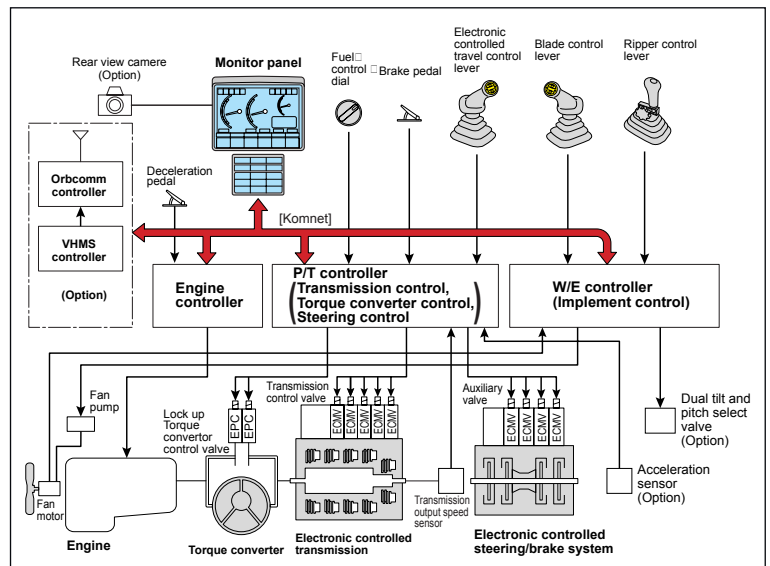

Power Train Electronic Control System

Smooth operation

D375A-6R uses a newly designed power train electronic control system. The controller registers the amount of operator control (movements of lever and operation of switches) and machine condition signals from each sensor, and calculates to accurately control torque converter, transmission, steering clutches and brakes for optimized machine operation. The ease of operation and productivity of the new D375A-6R is greatly improved by numerous new functions.

ECMV (Electronic Controlled Modulation Valve) controlled transmission

Controller automatically adjusts each clutch engagement depending on travel conditions such as gear speed, revolution and shifting pattern. This provides shockless smooth clutch engagement, improved component reliability, expansion of component life and operator riding comfort.

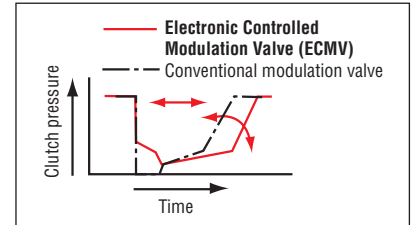

ECMV (Electronic Controlled Modulation Valve) controlled steering clutches/brakes

Sensors monitor machine operating conditions, and the controller activates ECMV electronically to control steering clutches and brakes depending on type of job, such as size of load during dozing, incline angle of slope or load, providing smooth and ease of operation by reducing counter-steering on downhill travel, etc.

Effect of ECMV steering clutches/brake control

When dozing and turning, ECMV automatically controls stroke ratio of steering clutches and brakes depending on degree of load, enabling smooth dozing and turning.

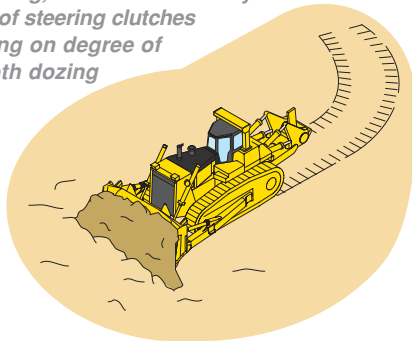

When dozing downhill, ECMV automatically controls steering clutches and brakes depending on incline of machine or degree of load, reducing counter-steering and producing smooth dozing operation.

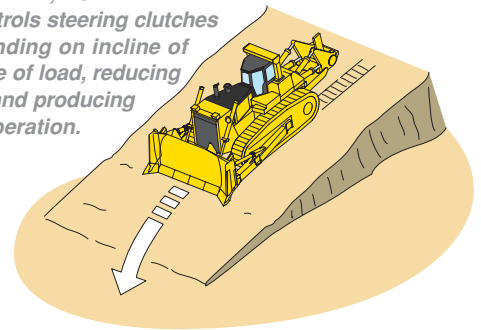

Preset travel speed selection function

When the gearshift pattern is set to either <F1-R2>, <F2-R2> or <F2-R3L> in automatic gearshift mode, the gear is automatically shifted, reducing round trip repetition work time and operator's efforts.

	Automatic gearshift mode	Manual gearshift mode	Shoe slip control mode (optional)
	F1-R1 MODE Press DOWN switch ↑ Press UP switch ↓	F1-R1 MODE Press DOWN switch ↑ Press UP switch ↓	F1-R1 MODE Press DOWN switch ↑ Press UP switch ↓
	F1-R2 MODE Press DOWN switch ↑ Press UP switch ↓	F1-R2 MODE Press DOWN switch ↑ Press UP switch ↓	F1-R2 MODE
	F2-R2 MODE Press DOWN switch ↑ Press UP switch ↓	F2-R2 MODE	
	F2-R3L MODE		

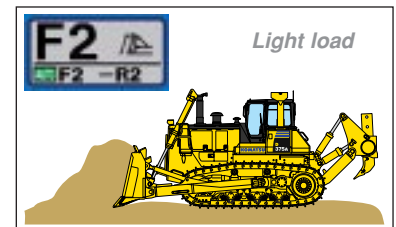
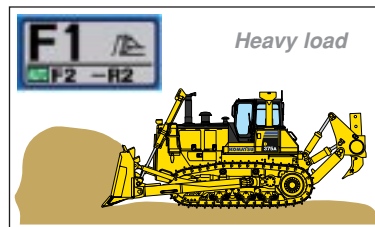

Auto downshift function

Controller monitors engine speed, travel gear and travel speed. When load is applied and machine travel speed is reduced, the transmission automatically downshifts to optimum gear speed to provide high fuel efficiency. This function provides comfortable operation without manual downshift and high productivity.

Actuated on heavy load or steep slope

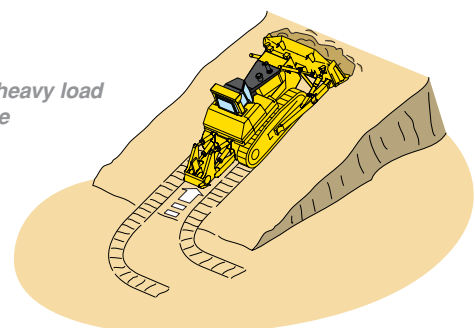

PRODUCTIVITY FEATURES

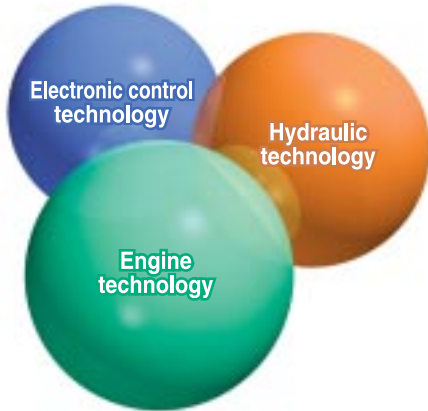

Engine

The Komatsu SAA6D170E-5 engine delivers **474 kW** 636 HP at 1800 rpm. The fuel-efficient Komatsu engine, together with the heavy machine weight, make the D375A-6R a superior crawler dozer in both ripping and dozing production. The engine features direct fuel injection, turbocharger, and air-to-air aftercooler to maximize fuel efficiency.

To minimize noise and vibration, the engine is mounted to the main frame with rubber cushions.

Hydraulic drive radiator cooling fan

Fan rotation is automatically controlled depending on coolant and hydraulic oil temperature, saving fuel consumption and providing great productivity with a quiet operating environment.

Automatic transmission with lockup torque converter

A sharp reduction in fuel consumption and greater power train efficiency is achieved by the new automatic gearshift transmission and lockup torque converter. The automatic gearshift transmission selects the optimal gear range depending on the working conditions and load placed on the machine. This means the machine is always operating at maximum efficiency. (Manual gearshift mode is selectable with a switch)

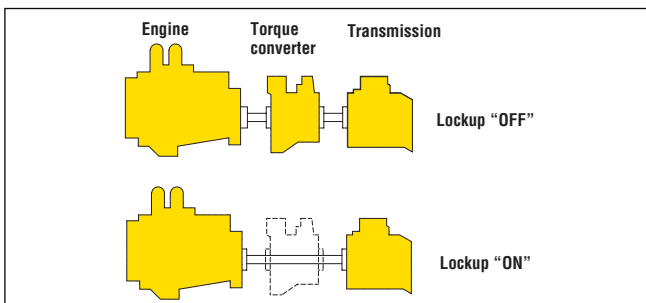

K-Bogie undercarriage system

K-Bogie undercarriage system combines prior advantages with additional features.

- Effective length of track on ground is consistent. Shoe slippage is minimized, resulting in higher traction.
- The idler does not oscillate under load, providing excellent machine balance. Blade and ripper penetration force remains stable for increased productivity.
- K-Bogies oscillate with two fulcrums, and track roller vertical travel is greatly increased. Impact loading to undercarriage components is reduced and component durability is improved since track rollers are always in contact with track link.
- Undercarriage life is improved due to better control of track chain alignment with track rollers.
- Riding comfort is improved by reducing vibration and shock when traveling over rough terrain.

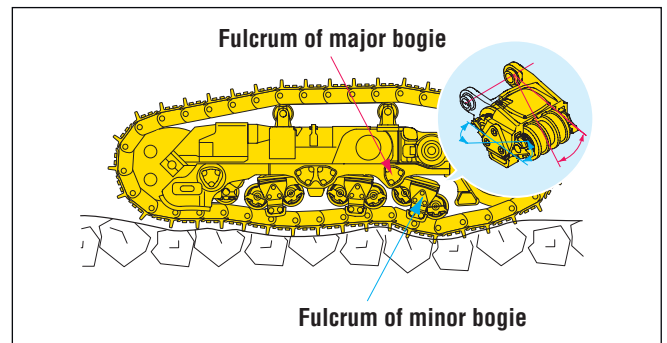

Large blade

Capacities of **18.5 m³** 24.2 yd³ (Semi-U dozer) and **22.0 m³** 28.8 yd³ (U dozer) yield outstanding production. High-tensile-strength steel comprising the front and sides of the blade increase durability. The shape of the blade features high load hauling efficiency.

Dual tilt dozer (optional)

The dual tilt dozer increases productivity while reducing operator effort.

- Optimum blade cutting angle for all types of materials and grades can be selected on-the-go for increased load and production.
- Digging, hauling, and dumping are easy and smooth with less operator fatigue.
- Dozer tilt angle and tilt speed are twice that of a conventional single tilt system.

Rippers (optional)

- The variable giant ripper features a long sprocket center-to-ripper point distance, making ripping operation easy and effective while maintaining high penetration force.
- The variable giant ripper is a parallelogram single shank ripper ideal for ripping tough material. The ripping angle is variable, and the depth is adjustable in three stages by a hydraulically controlled pin puller.
- The multi-shank ripper is a hydraulically controlled parallelogram ripper with three shanks.



Automatic/manual gearshift and shoe slip control (optional) selectable mode

Automatic or manual gearshift modes can be selected with ease to suit the work at hand by simply pressing the switch on the multi-monitor (The mode can be selected when the travel control joystick is at NEUTRAL.).

• **Automatic gearshift mode**

The mode for general dozing. When a load is applied, the gear automatically shifts down, and when the load is off, it automatically shifts up to a set maximum gear speed. This mode economizes both fuel and production where the torque converter lockup mechanism is actuated according to load, automatically selecting the optimum gear speed.

• **Manual gearshift mode**

The mode for dozing and ripping rough ground. When loaded, the gear automatically shifts down, but does not shift up when the load is off.

Working mode

This mode can be set to either “P mode” for the maximum power or “E mode” for energy saving operation. Combined with the automatic gearshift mode or manual gearshift mode, the working mode allows the operator to select the optimum machine operating condition for the work at hand. (The mode can be switched during operation.)

• **P Mode (Power mode)**

With P mode, the engine outputs its full power. Select this mode for the work requiring large production, heavy-load work, and uphill work.

• **E Mode (Economy mode)**

Select for energy saving operation with restricted engine power output.
 Select for the work on a ground where the machine may cause shoe slip and frequent decelerator pedal operation is required.
 Select for the work not requiring large power such as downhill dozing, leveling, and light-load work.

Working mode selector switch



P mode



E mode



Track shoe slip control mode (optional)

- Eliminates the need for the operator to constantly control engine power output with the decelerator pedal while ripping. Operator fatigue is substantially reduced.
- Maneuverability is improved because the operator is free to focus on the ripping application without having to monitor the track shoe slippage.
- Repair costs are significantly lowered and undercarriage life is prolonged with the reduction in track shoe slippage.
- The track shoe slip control system will contribute to lower fuel costs, because the engine output is automatically controlled to optimum levels for operation.

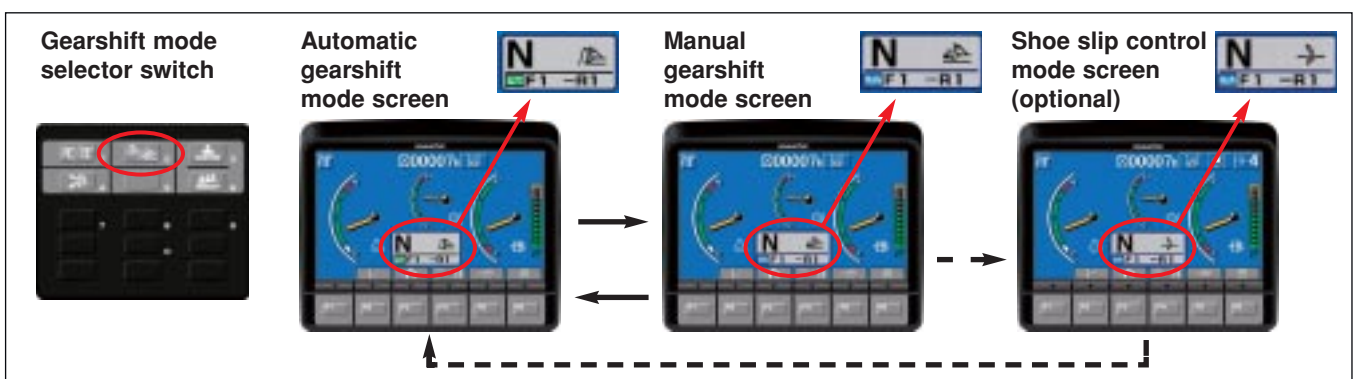

WORKING ENVIRONMENT



Photo may include optional equipment.



Hexagonal pressurized cab

- The cab's hexagonal design and large tinted glass windows provide excellent front, side and rear visibility.
- Air filters and a higher internal air pressure combine to prevent dust from entering the cab.

Fresh air intake from rear of engine hood

The air conditioner air intake port is now located at the rear of the engine hood where there is minimal dust. As a result, the air inside the cab is always clean. Cleaning interval of the filter is greatly extended, and use of a new structure filter element facilitates cleaning and replacement.

Large multi-lingual LCD color monitor

A large user-friendly color monitor enables safe, accurate and smooth work. Improved screen visibility is achieved by use of TFT (Thin Film Transistor) liquid crystal display that can easily be read at various angles and lighting conditions. Simple and easy to operate switches. Industry first function keys facilitate multi-function operations.

Display data in 10 languages to globally support operators around the world.



Comfortable ride with cab damper mounting and K-Bogie undercarriage

D375A-6R's cab mount uses a cab damper mounting which further improves viscous damper and provides excellent shock and vibration absorption capacity with its long stroke. The cab damper mounting, combined with K-bogie undercarriage, softens shocks and vibrations while traveling over adverse condition that are impossible to absorb with conventional cab mounting methods. The soft spring cab damper isolates the cab from machine body, suppressing vibrations and providing a quiet, comfortable operating environment.

Cab damper mounting

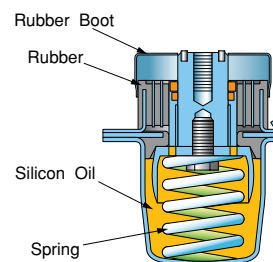

New suspension seat

D375A-6R uses a new suspension seat. Fore and aft sliding rails and suspension spring increases strength and rigidity and reduces play of joints. New seat provides excellent support and riding comfort. Fore and aft sliding amount is designed to fit all operators. In addition, air suspension seat with seat isolator is optionally available, that reduces vertical and lateral vibrations more effectively.

EASY MAINTENANCE

Preventative Maintenance

Preventative maintenance is the only way to ensure long service life from your equipment. That's why Komatsu designed the D375A-6R with conveniently located maintenance points to make necessary inspections and maintenance quick and easy.

Multi-monitor with troubleshooting function to prevent critical machine troubles

Various meters, gauges, and warning functions are centrally arranged on the multi-monitor. Offers ease of start-up inspection and promptly warns the operator with a lamp and buzzer if any abnormalities should occur. In addition, countermeasures are indicated in 4 stage codes to ensure safety and prevent the machine from major problems. Replacement times for oil and filters are also indicated.

Maintenance warning screen



Abnormality warning screen



Maintenance List screen for replacement time display

Centralized service station

To ensure convenient maintenance, the transmission and torque converter oil filters are both arranged next to the power train oil level gauge.

Oil pressure checking ports

Pressure checking ports for power train components are centralized to promote quick and simple diagnosis.

Enlarged engine room

Engine room space is enlarged by increasing engine hood height, facilitating maintenance of the engine and related equipment. Solid engine hood prevents dust and rain from entering and keeps the engine clean.

Gull-wing engine side covers

Gull-wing engine side covers facilitate engine maintenance and filter replacement. Side covers are a thick two-piece structure with bolt-on latch to improve durability and repairability.

Low Maintenance Costs

Track link with wedge ring

D375A-6R track links feature reduced press-fit force and a wedge ring. Conventional track pins are retained only with a large press-fit force. The track link divides pin forces between the wedge ring and press-fit force. This results in easier service with reduced pin damage when turning pins and bushings. The result is improved undercarriage life and reduced maintenance cost through reduced wear, greater pin reusability, and reduced maintenance man-hours.

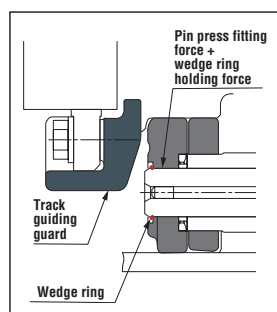

Highly reliable electric circuit

The electrical circuit reliability is increased by utilizing dust, vibration and corrosion resistant "DT connectors". The reinforced electrical wiring harnesses include a circuit breaker and are covered with a heat-resistant material to

increase mechanical strength, provide longer life, and protect the system from damage.

Flat face O-ring seals

Flat face O-ring seals are used to securely seal all hydraulic hose connections and to prevent oil leakage.

Enclosed hydraulic piping

Hydraulic piping for the blade tilt cylinder is completely housed in the push arm protecting it from damage.

Modular power train design

Power train components are sealed in a modular design that allows the components to be dismantled and mounted without oil spillage, making servicing work clean, smooth, and easy.

Maintenance-free disc brakes

Wet disc brakes require less maintenance.

RELIABILITY FEATURES

Filtration

Engine

Newly high efficient main fuel filter and water separator help protect the engine against dust and water in the fuel.



The fuel tank is equipped with a high-filtration breather with pressure valve to help prevent dust from entering.



Hydraulic

The hydraulic tank is equipped with a high-filtration breather with pressure valve to help prevent dust from entering.



SPECIFICATIONS



ENGINE

Model Komatsu SAA6D170E-5
 Type 4-cycle, water-cooled, direct injection
 Aspiration Turbocharged, air-to-air aftercooled
 Number of cylinders 6
 Bore x stroke **170 mm x 170 mm** 6.69" x 6.69"
 Piston displacement **23.15 ltr** 1,413 in³
 Governor All-speed and mid-range, electronic
 Horsepower
 SAE J1995 Gross **474 kW** 636 HP
 ISO 9249 / SAE J1349* Net **455 kW** 610 HP
 Rated rpm 1800 rpm
 Fan drive type Hydraulic
 Lubrication system
 Method Gear pump, force lubrication
 Filter Full-flow
 *Net horsepower at the maximum speed of
 radiator cooling fan **433 kW** 580 HP



TORQFLOW TRANSMISSION

Komatsu TORQFLOW transmission consists of a water-cooled, 3-element, 1-stage, 1-phase torque converter with lockup clutch and a planetary gear, multiple-disc clutch transmission which is hydraulically actuated and force-lubricated for optimum heat dissipation. Gearshift lock lever and neutral safety switch prevent accidental starts.

Gear	Forward		Reverse	
	km/h	mph	km/h	mph
1st	3.5	2.2	4.6	2.9
2nd	6.8	4.2	8.9	5.5
3rd L	8.0	5.0	9.7	6.0
3rd	11.8	7.3	15.8	9.8

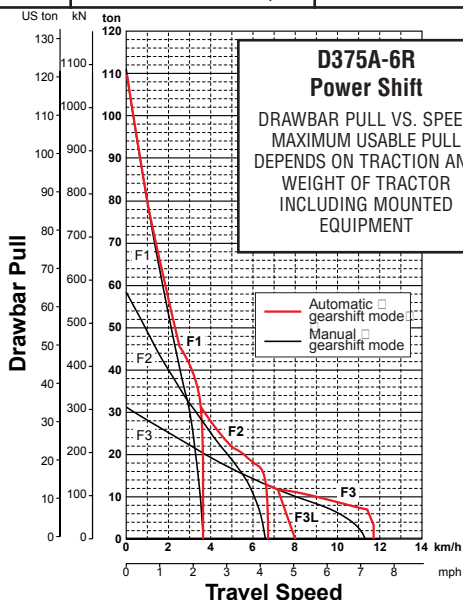

FINAL DRIVES

Double-reduction final drive of spur and planetary gear sets to increase tractive effort and reduce gear tooth stresses for long final drive life. Segmented sprocket teeth are bolt-on for easy replacement.



STEERING SYSTEM

PCCS, joystick controlled, wet multiple-disc steering clutches are spring-loaded and hydraulically released. Wet multiple-disc, pedal/lever controlled steering brakes are spring-actuated hydraulically released and require no adjustment. Steering clutches and brakes are interconnected for easy, responsive steering.

Minimum turning radius **4.2 m** 13'9"



UNDERCARRIAGE

Suspension Oscillating equalizer bar and pivot shaft
 Track roller frame Cylindrical, high-tensile-strength steel construction
 Rollers and idlers Lubricated track rollers

K-Bogie undercarriage

Lubricated track rollers are resiliently mounted to the track frame with a bogie suspension system whose oscillating motion is cushioned by rubber pads.

Extreme service track shoes

Lubricated tracks. Unique seals prevent entry of foreign abrasives into pin to bushing clearances to provide extended service life. Track tension is easily adjusted with grease gun.

Number of shoes (each side) 40
 Grouser height:
 Single grouser **93 mm** 3.7"
 Shoe width (standard) **610 mm** 24"
 Ground contact area **46850 cm²** 7,262 in²
 Ground pressure (tractor) **108 kPa** 1.10 kg/cm² 15.6 psi
 Number of track rollers 7
 Number of carrier rollers 2

Extreme service shoes	Additional weight	Ground contact area	Ground pressure
710 mm 28"	660 kg 1,460 lb	54530 cm² 8,452 in ²	125 kPa 1.27 kgf/cm ² 18.1 psi
810 mm 32"	1330 kg 2,930 lb	62210 cm² 9,643 in ²	110 kPa 1.12 kgf/cm ² 15.9 psi



COOLANT AND LUBRICANT CAPACITY (REFILL)

Fuel tank **1200 ltr** 317.0 U.S. gal
 Coolant **120 ltr** 31.7 U.S. gal
 Engine **86 ltr** 22.7 U.S. gal
 Torque converter, transmission,
 bevel gear, and steering system **150 ltr** 39.6 U.S. gal
 Final drive (each side) **65 ltr** 17.1 U.S. gal

DIMENSIONS

SEMI-U DOZER WITH GIANT RIPPER

A	2500 mm	8'2"
B	4695 mm	15'5"
C	4215 mm	13'10"
D	2265 mm	7'5"
E	3840 mm	12'7"
F	10515 mm	34'6"
G	3450 mm	11'4"
H	1538 mm	5'1"
I	1050 mm	3'5"
J	4235 mm	13'11"

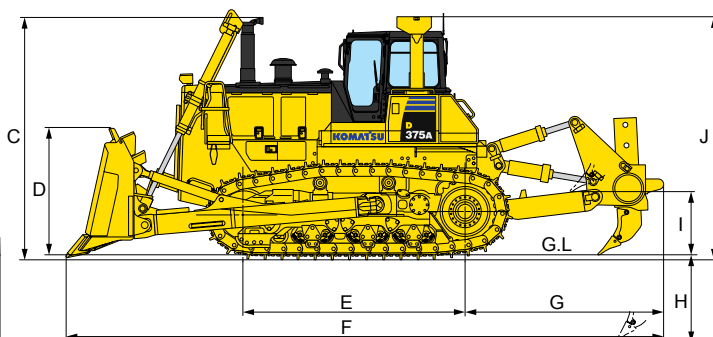
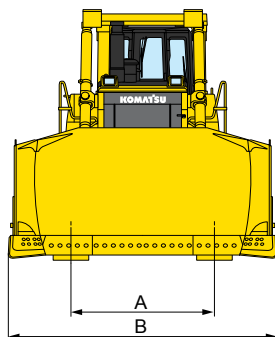

Ground Clearance: **610 mm 2'0"**

OPERATING WEIGHT

Tractor weight **51800 kg** 114,200 lb
Including rated capacity of lubricant, coolant, full fuel tank, operator, and standard equipment.

Operating weight **70235 kg** 154,840 lb
Including Semi-U tilt dozer, giant ripper, cab, ROPS, operator, standard equipment, rated capacity of lubricant, coolant, and full fuel tank.

Ground pressure **147 kPa** 1.50 kg/cm² 21.3 psi

HYDRAULIC SYSTEM

Hydraulic control unit:
Closed-center load sensing system (CLSS) designed for precise and responsive control, and for efficient simultaneous operation.

Hydraulic control unit:
All spool control valves externally mounted beside the hydraulic tank. Variable piston pump with capacity (discharge flow) of **366 ltr/min** 96.7 U.S. gal/min for implement at rated engine rpm. Relief valve setting . . . for implement **27.5 MPa** 280 kg/cm² 3,980 psi

Control valves:
Spool control valve for Semi-U tilt dozer and Full-U tilt dozer.
Positions: Blade lift Raise, hold, lower, and float
Blade tilt Right, hold, and left

Additional control valve required for variable digging angle multi-shank ripper and giant ripper.
Positions: Ripper lift Raise, hold, and lower
Ripper tilt Increase, hold, and decrease

Hydraulic cylinders Double-acting, piston

	Number of cylinders	Bore
Blade lift	2	140 mm 5.5"
Blade tilt	1	200 mm 7.9"
Ripper lift	2	200 mm 7.9"
Ripper tilt	2	180 mm 7.1"

Hydraulic oil capacity (refill):
Semi-U dozer or U dozer **130 ltr** 34.4 U.S. gal
Ripper equipment (additional volume):
Giant ripper **45 ltr** 11.9 U.S. gal
Multi-shank ripper (variable) **45 ltr** 11.9 U.S. gal

DOZER EQUIPMENT

Blade capacities are based on the SAE recommended practice J1265.

	Overall length with dozer	Blade capacity	Blade length x height (with spill guard height)	Maximum lift above ground	Maximum drop below ground	Maximum tilt adjustment	Weight		Ground Pressure*
							Dozer equipment	Hydraulic oil	
Semi-U dozer	7820 mm 25'8"	18.5 m³ 24.2 yd ³	4695 mm x 2265 mm 15'5" x 7'5"	1642 mm 5'5"	800 mm 2'7"	970 mm 3'2"	10920 kg 24,070 lb	45 kg 100 lb	147 kPa 1.50 kgf/cm² 21.3 psi
Strengthened Semi-U dozer	7820 mm 25'8"	18.5 m³ 24.2 yd ³	4695 mm x 2265 mm 15'5" x 7'5"	1642 mm 5'5"	800 mm 2'7"	970 mm 3'2"	11390 kg 25,110 lb	45 kg 100 lb	148 kPa 1.51 kgf/cm² 21.5 psi
Strengthened U dozer with spill guard	8180 mm 25'10"	22.0 m³ 28.8 yd ³	5140 mm x 2265 mm (2525 mm) 16'10" x 7'5" (8'3")	1642 mm 5'5"	800 mm 2'7"	1065 mm 3'6"	12420 kg 27,380 lb	45 kg 100 lb	150 kPa 1.53 kgf/cm² 21.8 psi
Dual tilt Semi-U dozer	7820 mm 25'8"	18.5 m³ 24.2 yd ³	4695 mm x 2265 mm 15'5" x 7'5"	1642 mm 5'5"	800 mm 2'7"	1185 mm 3'11"	11100 kg 24,470 lb	50 kg 110 lb	147 kPa 1.50 kgf/cm² 21.3 psi
Strengthened Dual tilt Semi-U dozer	7820 mm 25'8"	18.5 m³ 24.2 yd ³	4695 mm x 2265 mm 15'5" x 7'5"	1642 mm 5'5"	800 mm 2'7"	1185 mm 3'11"	11570 kg 25,510 lb	50 kg 110 lb	148 kPa 1.51 kgf/cm² 21.5 psi
Strengthened dual tilt U dozer with spill guard	8180 mm 25'10"	22.0 m³ 28.8 yd ³	5140 mm x 2265 mm (2525 mm) 16'10" x 7'5" (8'3")	1642 mm 5'5"	800 mm 2'7"	1300 mm 4'3"	12600 kg 27,780 lb	50 kg 110 lb	151 kPa 1.54 kgf/cm² 21.9 psi

*Ground pressure shows tractor with cab, ROPS, variable giant ripper, standard equipment and applicable blade.

D375A-6R CRAWLER DOZER



STANDARD EQUIPMENT

- Alternator, 60 ampere/24 V
- Back-up alarm
- Batteries, 170 Ah/2 x 12 V
- Blower cooling fan
- Color monitor
- Decelerator pedal
- Dry-type air cleaner with dust evacuator and dust indicator
- Electrical dust indicator
- Final drive case wear guard
- Hinged front mask
- Hinged underguards with front pull hook
- Horn, warning
- Hydraulics for dozer
- Hydraulic track adjusters
- Lighting system (including four front and two rear lights)
- Lockup torque converter
- Muffler with rain cap
- PCCS lever steering control
- Perforated side covers
- Radiator reserve tank
- ROPS brackets
- Segmented sprockets
- Seven track roller
- Shoes, **610 mm 24"** extreme service, single-grouser
- Starting motors, 2 x 7.5 kW/24 V
- Suspension seat
- TORQFLOW transmissions
- Track roller guards
- Wet steering clutches



OPTIONAL EQUIPMENT

- Air conditioner with heater and defroster
- Alternator, 90 ampere/24 V
- Batteries, 200 Ah/2 x 12 V
- Car stereo
- Counterweight
- Double wiper for cab door
- Dual tilt dozer
- End bits
 - Efficiency type
- Fast fill fuel system
- Fire extinguisher
- HID lights
- High mount head lights
- Hitch
- Hydraulics for ripper
- Inspection light
- Light for ripper point
- Lunch box holder
- Mirror, rearview
- Panel cover
- Rear view monitoring system
- Seat
 - Air suspension seat
 - Fabric seat
 - Air suspension seat with seat isolator
 - Fabric seat
 - Suspension seat
 - Fabric seat
 - Fabric seat, high backrest
- Seat belt
- Shoes:
 - 710 mm 28"**
 - 810 mm 32"**
- Spare parts for first service
- Spill guard for Semi-U dozer
- Starting motors, 2x11kw/24V
- Strengthened Semi-U blade
- Strengthened U blade with spill guard
- Sun visor
- Tool kit
- Track shoe slip control system
- Vandalism protection kit (cover locks)
- VHMS or VHMS with Orbcomm

ROPS*:

Weight **700 kg** 1,540 lb
 Roof dimensions:
 Width **1980 mm** 6'6"
 Height from
 compartment floor **1872 mm** 6'2"
 *Meets ISO 3471 and SAE J1040 APR88, ROPS standards.

Steel cab*:

Weight **570 kg** 1,260 lb
 Dimensions:
 Length **1875 mm** 6'2"
 Width **1740 mm** 5'9"
 Height from compartment
 floor to ceiling **1630 mm** 5'4"
 *Meets ISO 3449 FOPS standard.

Multi-shank ripper:

Hydraulically controlled parallelogram ripper with three shanks. Ripping angle is steplessly adjustable.
 Weight (including hydraulic control unit and oil) **6800 kg** 14,990 lb
 Beam length **2910 mm** 9'7"
 Maximum lift above ground . . **1082 mm** 3'7"
 Maximum digging depth . . **1190 mm** 3'11"

Variable giant ripper:

Variable, parallelogram single-shank ripper ideal for ripping up tough material. Ripping angle is variable. Ripping depth is adjustable in three stages by a hydraulically controlled pin puller.
 Weight (including hydraulic control unit and oil).....**6200 kg** 13,670 lb
 Beam length.....**1453 mm** 4'9"
 Maximum lift above ground....**1050 mm** 3'5"
 Maximum digging depth.....**1538 mm** 5'1"

KOMATSU[®]